

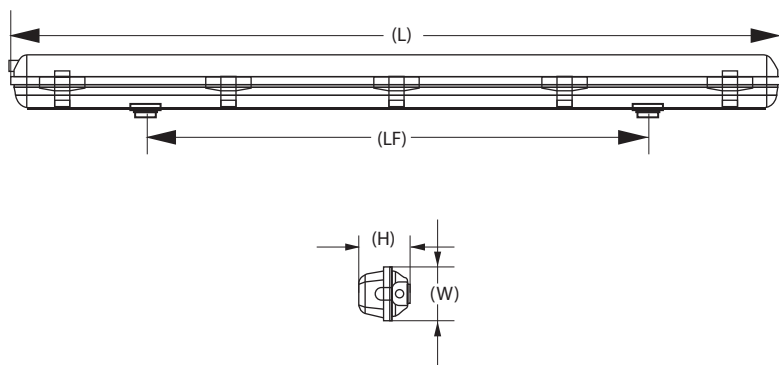

Duro LED T8 1L



DIMENSIONS



DIMENSION OF FITTING

Product Code	Model Code	L mm	W mm	H mm	LF mm	Weight kg
DU140T8	DU140T8	1270	93	100	905	1.46

* refer to T8LED tube catalogue for wattage & lumens

INTENDED USE

Duro LED T8 1L weatherproof is a high quality luminaire with a high system efficacy that delivers significant energy savings of up to 50% as compared to conventional T8 battens. With a reliable and robust housing structure, this maximizes the endurance and contributes to its long lifetime. Suitable to use in Industry such as automotive assembly line, food and beverage general areas, corridors / walkways, indoor car parks.

CONSTRUCTION AND OPTICS

IP66. For use where moisture or dust is prevalent. Designed with shallow and compact housing for ease of installation. The polycarbonate body and clear polycarbonate diffuser for maximum durability. All fixing clips are stainless steel as standard.

LINE DRAWING

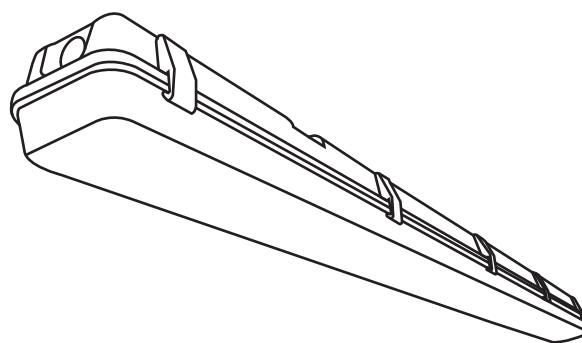

Stainless Steel Clips



Specifications and dimension subject to change without notice